

## E1. Lens Types

Common lenses are made of glass, shaped with spherical surfaces. The spherical choice is due to the ease in grinding uniform curvatures. Lenses, like mirrors, are important optical elements used in countless applications. The table below relates the basic principles of physics to the applications.

### Basic Laws of Physics and Optical Applications

Physics Principle	Optical Element
Reflection	Mirrors
Refraction	Lenses

The basic types of spherical mirrors and lenses are summarized in the next table.

### Basic Types of Spherical Mirrors and Lenses

Category	Name
Mirror	Convex
	Concave
Lens	Diverging
	Converging

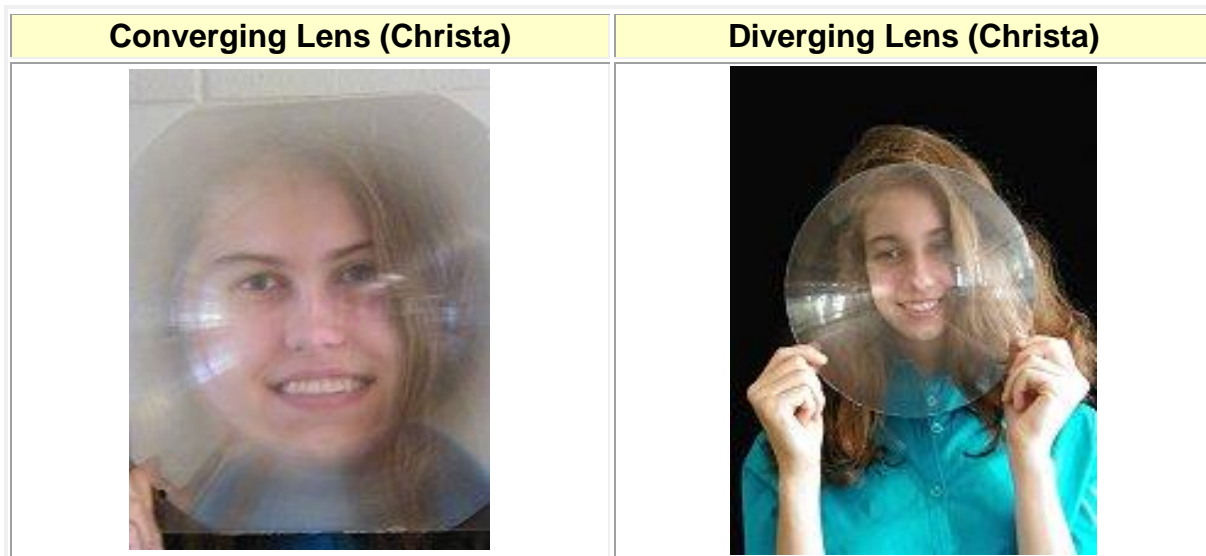

*Photographs by Wendy Newman, June 5, 2002 in RH 119.*

Demonstration lenses are often employed in physics classes to illustrate properties of lenses. These lenses are cut so that they can be placed against a wall allowing light rays to skim the wall surface (see below).

### Blackboard Optics' for Class Demonstration

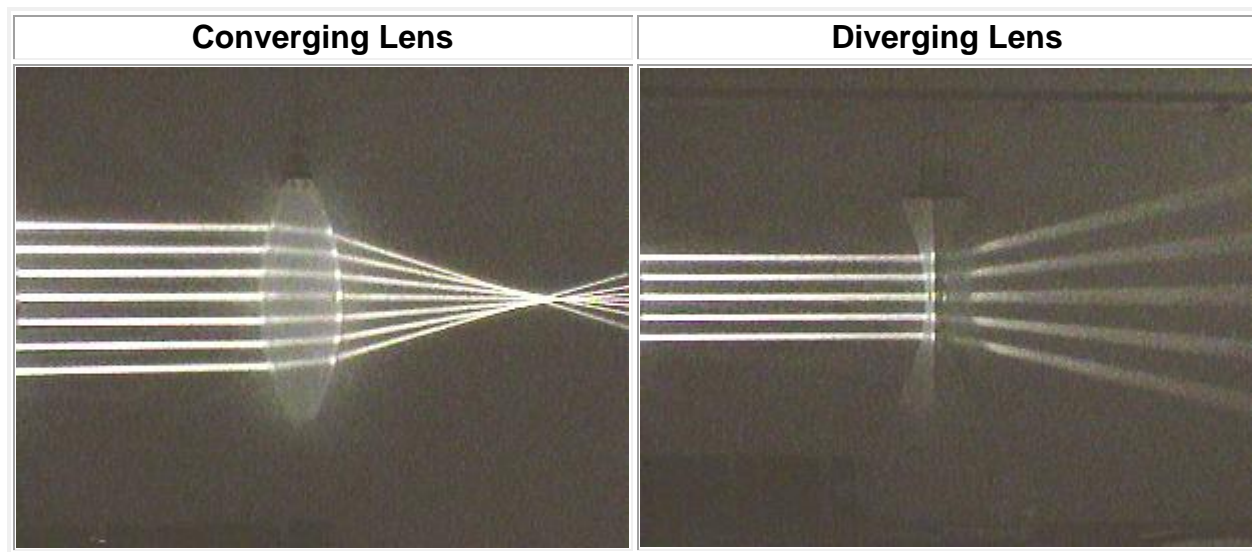

*Courtesy Richard E. Berg, Lecture Demonstration Facility, University of Maryland*

A **converging lens** refracts parallel light rays toward a point, i.e., the parallel rays converge. These rays keep going in the above left photo since there is nothing to stop them.

The **diverging lens** refracts parallel light so that the outgoing rays diverge instead of converge.

Notice that the converging lens has convex surfaces, while the diverging lens is concave on each side. A converging lens is also called a **convex lens** and a diverging lens is referred to as a **concave lens**. Don't get confused with mirrors since parallel rays reflecting from a convex mirror diverge, i.e., do the opposite when compared to a convex lens. Similarly, for the concave mirror and concave lens we find opposite behavior. Most of the time, we will use the converging and diverging terminology to emphasize what is going on.

Look carefully at the right photo above. You will see that the diverging lens has been made by joining together two pieces of glass. The left piece is concave on the left side and flat on the right, which right side you find in the middle of the combination. The second piece is flat on the left and concave on the right. Each of these pieces are more precisely referred to as **plano-concave**, meaning one surface is planar and the other concave.

## Rough Sketch of Above Blackboard Optics Demonstration

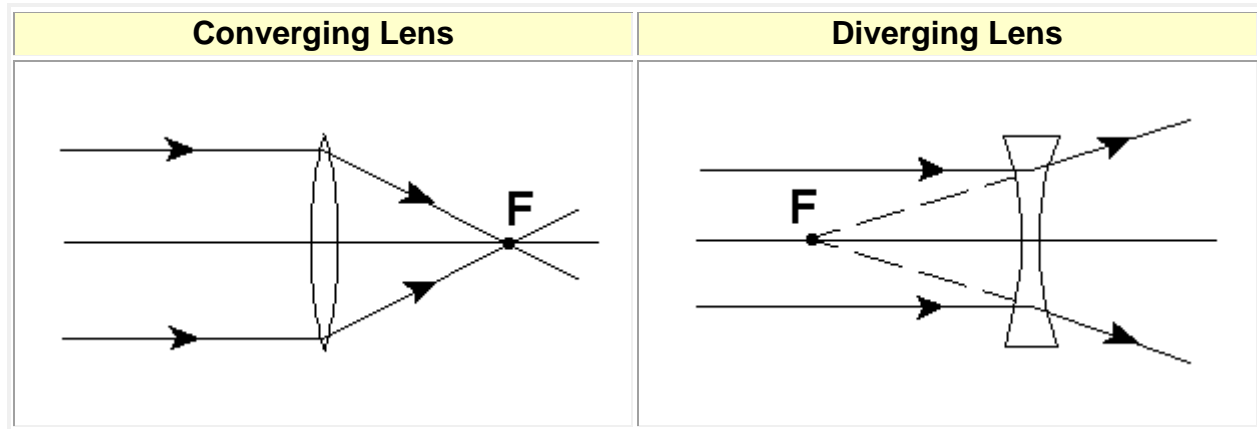

A sketch of our observations appears above. The point where parallel light is brought to a point by a converging lens is called the **focus point** or **focus**. A magnifying glass is a converging lens and on a sunny day, light from the Sun can be focused to a point. But the point is bright. Don't stare at it.

The Sun is so far away that the rays of sunlight reaching the lens can be considered parallel. The **focus** is therefore the point where the **sun's rays meet**. The distance from the converging lens to the focus is called the **focal length**. These are similar definitions to the ones we employed with spherical mirrors.

Strictly speaking, the diverging lens does not have a focus since entering parallel light diverges on leaving the lens. However, the divergent rays appear to originate from a common point. We call this point the focus for a diverging lens, but refer to it as a **virtual focus** or **virtual focal point**. The focal length for a diverging lens is defined as the distance from the virtual focus to the lens, but a minus sign is included in order to distinguish between the two types of lenses.

### Three-Word Puns

Speaking about the focus of a lens brings us to a perfect triple-word pun. A triple-word pun is very rare to come by. Here is one sent to your instructor by his mother during the 1980s. There are three puns here, but we do not consider this a perfect triple-word pun since the three puns are not consecutive. The words in between keep it from being a perfect triple pun.

"The symphony was playing Beethoven's Ninth. The men who manned the bass horns were bored. Their only part was a couple of deep toots right at the end. They decided to sneak across to the tavern for a beer. They thought in all decency they should give the director notice.

So they wrote a note, 'Have gone across the street for a beer.' They attached it by a paper clip to the last page, but made a mistake and clipped two pages together.

The director waved the baton expertly. Then he came to the next to the last page, turned the sheet, and to his consternation found the note.

He stopped the music and announced in dismay: 'It's the end of the Ninth, the score is tied and the basses are loaded.'" Dan O'Briant, *Atlanta Constitution*, Quote.

### Perfect Three-Word Pun

Now for the perfect pun, which first appeared sometime in the 1940s and reappeared in the 1970s in a *Peanuts Cartoon*. A family with three sons owned a cattle farm. When the father passed away the land was divided up into three parts and one part was inherited by each son. The family's house was situated in the center of the large farm. They wanted a name for the house and surrounding lands. Their mother suggested "Focus" since that is where the ...

<b>Sons</b>	<b>Raise</b>	<b>Meat</b>
<b>Sun's</b>	<b>Rays</b>	<b>Meet</b>

## E2. Diverging Lens

**Ray 1**, the parallel ray, for a diverging lens is shown below. The top of the diverging lens can be approximated as a triangle. The refraction occurs at the two interfaces: air-glass and glass-air (left figure). Light bends toward the normal as light enters glass from air. Then the light travels in a straight line through the glass until it reaches the second interface. At this latter glass-air interface, the light refracts away from the normal. The net effect is for the light to diverge away from the optic axis. In the second figure we simplify our sketch to show the net effect, making one bend in the middle of the glass. Of course, in reality the light refracts at the surfaces.

### Ray 1 for Diverging Lens: Parallel Ray Refracts as If Coming From F

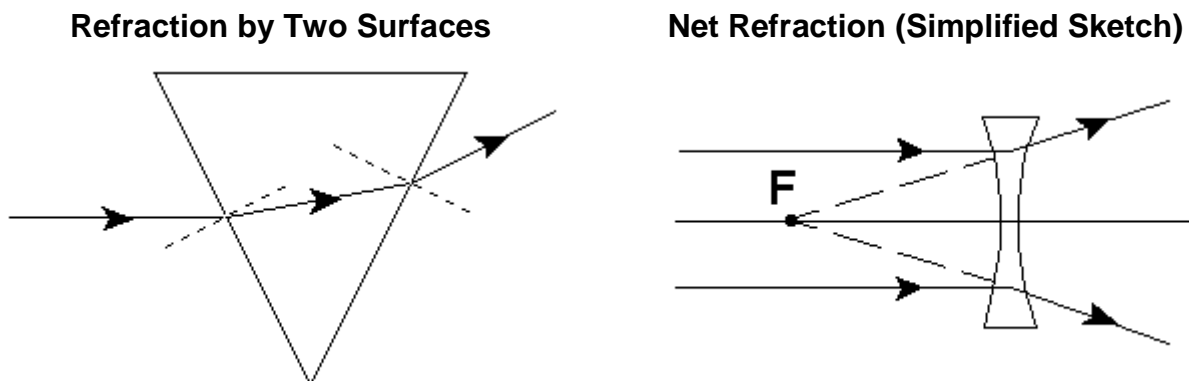

The lower parallel ray seen in the right diagram refracts downward at both the air-glass and glass-air interfaces due to the curvature of the interface in each case. Imagine the above triangle flipped the other way. In conclusion, the rule for Ray 1 for a diverging lens is that parallel light refracts as if coming from the point F.

**Ray 2** for a diverging lens is one that passes through the middle of the lens. The region in the center of the lens is fairly flat. If light passes through a flat piece of glass, the light refracts twice; however, there is no change in direction. See the left diagram below. If you look carefully at the left diagram, you will see that the outgoing light ray is raised slightly since the ray in the glass bends upward. For thin glass, we can neglect this. Regular pane glass windows are thin enough that you don't notice anything strange going on. You can look right out of a glass window and often not realize there is glass there at all.

Once around 1990 a guy walked through a glass door at the Registrar and broke it. He was okay though. Then years later (c. 2000) a gentlemen tried to walk through the inner glass door near the Department of Physics entrance to Robinson Hall - he didn't recognize it was a door. The glass didn't break that time.

### Ray 2 for Diverging Lens: Ray Through Center Passes Straight Through

Light Through Pane Glass

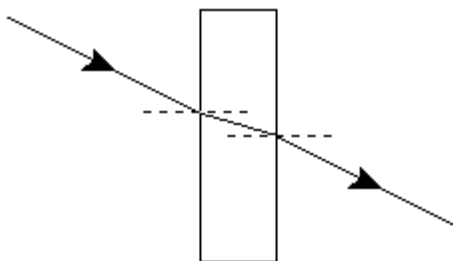

Net Refraction (Simplified Sketch)

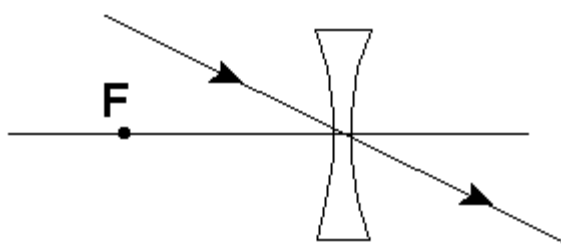

The rule for Ray 2 is that light passes through the center, continues undeviated. In our simplified sketch above, we simply draw the ray straight through.

**Ray 3.** For the third ray we need the focal point on the other side. Since our lens can be held either way, there is a focal point on each side. Remember how we ran Ray 1 in reverse to arrive at Ray 3 for the spherical mirror. We can think this way here also. Below, we aim at the F on the other side of the lens and the ray goes out parallel.

### Ray 3 for Converging Lens: Ray Aimed at Second F Leaves Parallel

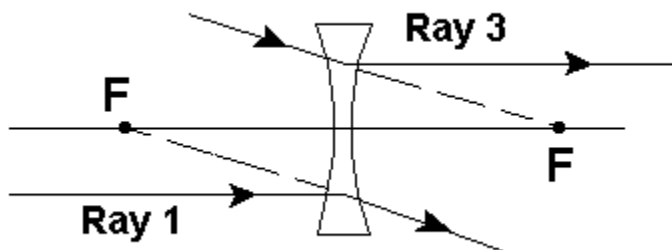

For Ray 1 we think parallel first then F. For Ray 3 we think the opposite, considering F (the one of the other side) first and then obtaining a parallel ray. Here is a summary of the three key rays for the diverging lens.

### Ray Rules for Diverging Lens

Ray	Rule
1	Parallel to the optic axis, refracts as if coming from F.
2	Goes to the center, passes straight through.
3	Aimed at F on the other side, refracts parallel to the optic axis.

It is very nice that we do not have to draw normals and use the law of refraction for each ray when we analyze the diverging lens. We simply use our derived ray rules, which we have arrived at from the law of refraction. Images appear small as an observer looks through a diverging lens.

### Diverging Lens



*Photo by Doc Ruiz, February 27, 2002*

**Diverging Lens Ray Diagrams.** We only need two of the key rays in order to locate an image due to a diverging lens. This is the case in general with mirrors and lenses. The basic steps are outlined below.

- Sketch the diverging lens and a central horizontal line (the optic axis). Label the points F.
- Sketch a vertical object arrow.
- Draw Ray 1 from the tip of the arrow to the lens. This ray is parallel to the optic axis.
- Use the rule for Ray 1 to sketch the refracted ray. Always place a small direction arrow on each ray.
- Draw Ray 2 from the tip of the arrow. This ray passes straight through the center.
- The image of the arrow tip is where the divergent rays appear to come from.
- Sketch in the vertical arrow (image) with a dotted line to indicate virtual image.

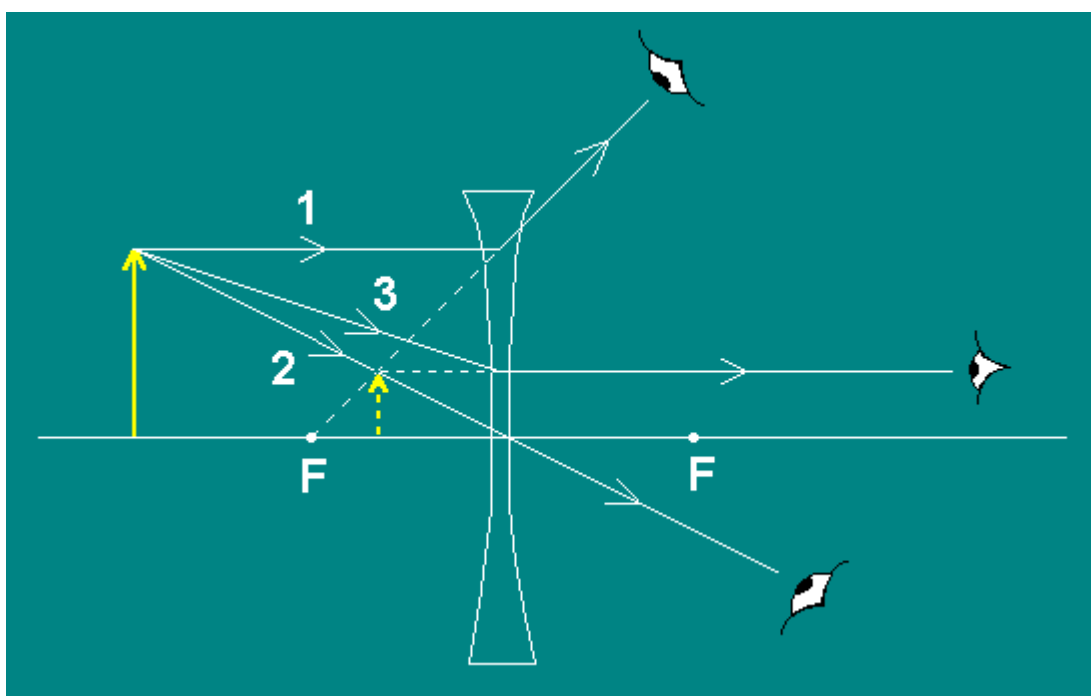

Ray 3 is aimed at the F on the right side of the lens. As we have done before, we conclude that the location of the image is where the light rays, extended backwards, intersect. Note that Ray 2 is the only ray that actually passes through the image tip. However, since all other rays need to be extended backwards, the image is virtual. For a real image, all of the rays must actually pass through the image. Each observer concludes that the image is in the unique location illustrated above. The virtual image is smaller and upright.

The diverging lens must be thin since our ray rules are based on the assumption of a thin lens. When you make your own sketches, you can draw a vertical line for the diverging lens, similar to what you did for spherical mirrors.

You only need two rays to locate the image.

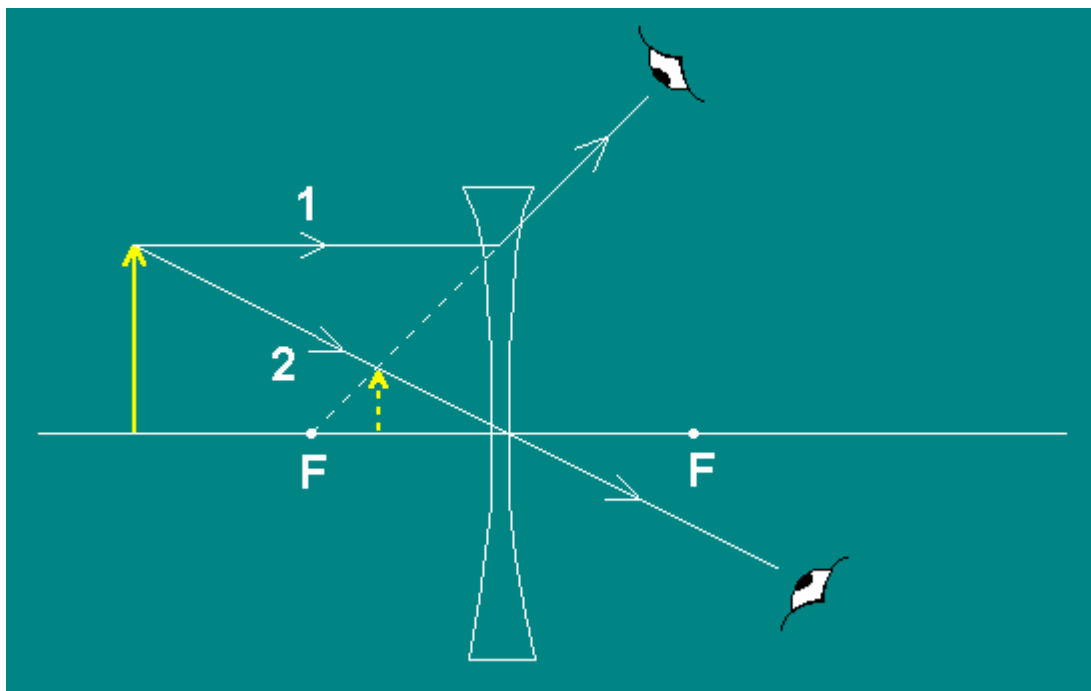

Below is a table summarizing characteristics of the image for different object locations. Again, it is convenient to define Point O as the point where the lens intersects the optic axis. Simply think of Point O as the center of the thin lens.

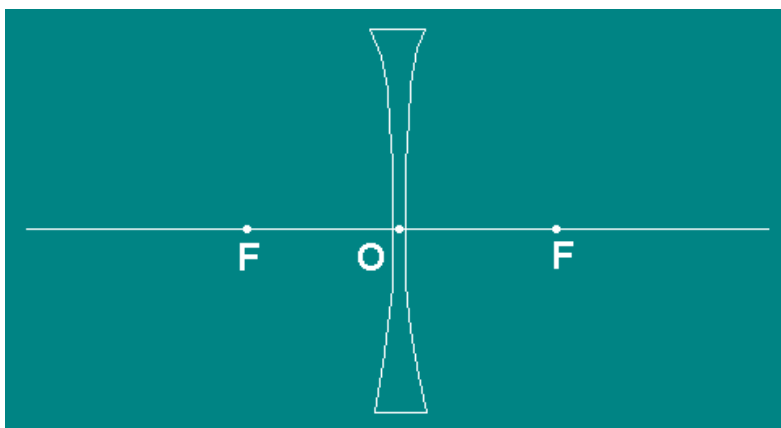

Object Location	Image Characteristics		
	Size	Location	Type
Infinity	Zero	At Left F	Virtual
Between Infinity and the Lens	Smaller	Between Left F and O	Virtual
Touching the Lens	Same Size	At the Lens	Virtual



### E3. Converging Lens

**Ray 1** for a converging lens is shown below. The refraction occurs at the two interfaces similar to the refraction that occurs by the surfaces shown in the left figure. Light bends toward the normal as light enters glass from air. Then the light travels in a straight line through the glass until it reaches the second interface. At this latter glass-air interface, the light refracts away from the normal. The net effect is for the light to converge toward the optic axis. In the second figure we simplify our sketch to show the net effect occurring in the middle of the glass. Of course, in reality the light refracts at the surfaces.

#### Ray 1 for Converging Lens: Parallel Ray Refracts Through F

Refraction at Upper Part of Lens

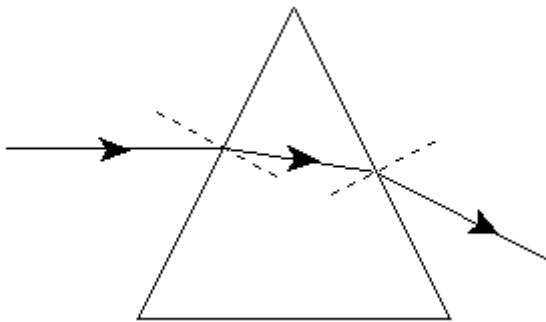

Net Refraction (Simplified Sketch)

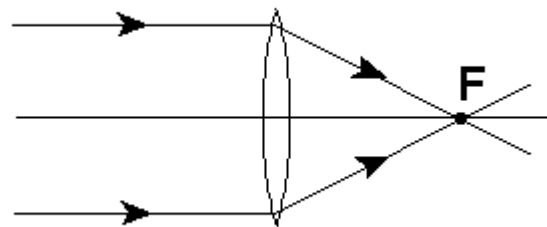

The lower parallel ray refracts upward at both the air-glass and glass-air interfaces due the curvature of the interface in each case. Imagine the above triangle flipped the other way. In conclusion, the rule for Ray 1 for a converging lens is that parallel light refracts so that the outgoing rays travel to F, where they cross and continue if unobstructed.

**Ray 2** for a converging lens behaves the same way that Ray 2 does for the diverging lens. The central region of the lens can be approximated as a thin flat piece of glass

#### Ray 2 for Diverging Lens: Ray Through Center Passes Straight Through

Light Through Pane Glass

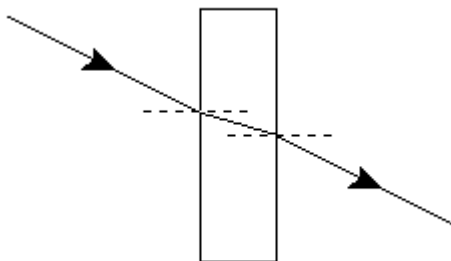

Net Refraction (Simplified Sketch)

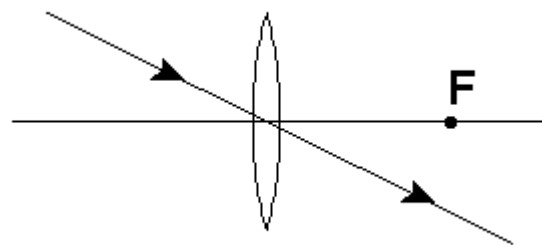

The rule for Ray 2 is that light passes through the center, continues undeviated. In our simplified sketch above, we simply draw the ray straight through. For a thin lens we can neglect the slight shift in the outgoing ray evident in the left diagram.

**Ray 3.** For the third ray we need the focal point on the other side. Remember that since a lens can be held either way, there is a focal point on each side. Recall how we ran Ray 1 in reverse to arrive at Ray 3 before. We can think this way again. Below, we go through the F on the left side of the lens and the ray goes out parallel.

### Ray 3 for Converging Lens: Ray Goes Through Left F and Leaves Parallel

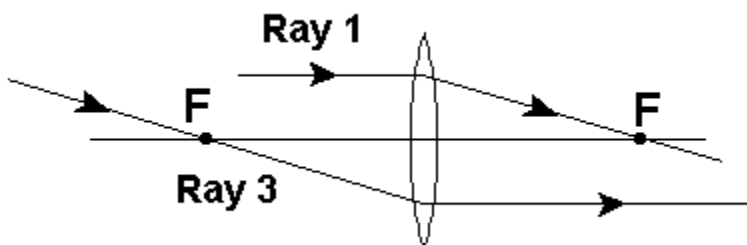

For Ray 1 we think parallel first then F. For Ray 3 we think the opposite, considering F (the one on the other side) first and then obtaining a parallel ray. Here is a summary of the three key rays for the converging lens.

### Ray Rules for Converging Lens

Ray	Rule
1	Parallel to the optic axis, refracts through F.
2	Passes through the center of the lens, going straight through.
3	Passes through F and refracts parallel to the optic axis.

As with the diverging lens, we do not have to draw normals and use the law of refraction for each ray when we sketch ray diagrams. We simply use our derived ray rules, which we have arrived at from the law of refraction

The laws for the converging and diverging lens are so close in wording that you can remember one set of rules. For Ray 1, think "refracts through" (right F for converging lens) or "as if coming from" (left F for diverging lens). For Ray 2, you go through the center of the lens undeviated. For Ray 3, you either go through the left F (converging), or aim at the right F (diverging), with the result that the outgoing ray is parallel.

## Combined Ray Rules for Lenses

Ray	Rule
1	Parallel to the optic axis, refracts through left F or as if coming from there.
2	Passes through the center of the lens, going straight through.
3	Passes through left F or aims at right F and refracts parallel to the optic axis.

Can you think of a super framework that combines the spherical mirror rules with those of the lenses?

Similar to the concave mirror, the converging lens produces a variety of different image characteristics depending on how far objects are away from it. We first investigate the case of the smaller, real, inverted image. This is illustrated in the photo below. Note the small inverted images for light passing through the lens. The image of the deck rail is inverted. As we will find by analysis, these inverted images are located between the observer (camera) and the lens. Since the camera focus is set at close range for this photo, the farther surrounding environment is blurred.

### Converging Lens Producing Inverted Smaller Real Image



*Photo by Doc Ruiz, February 27, 2002*

We now proceed to sketch a diagram for the above photo. You only need two of the key rays to locate the image.

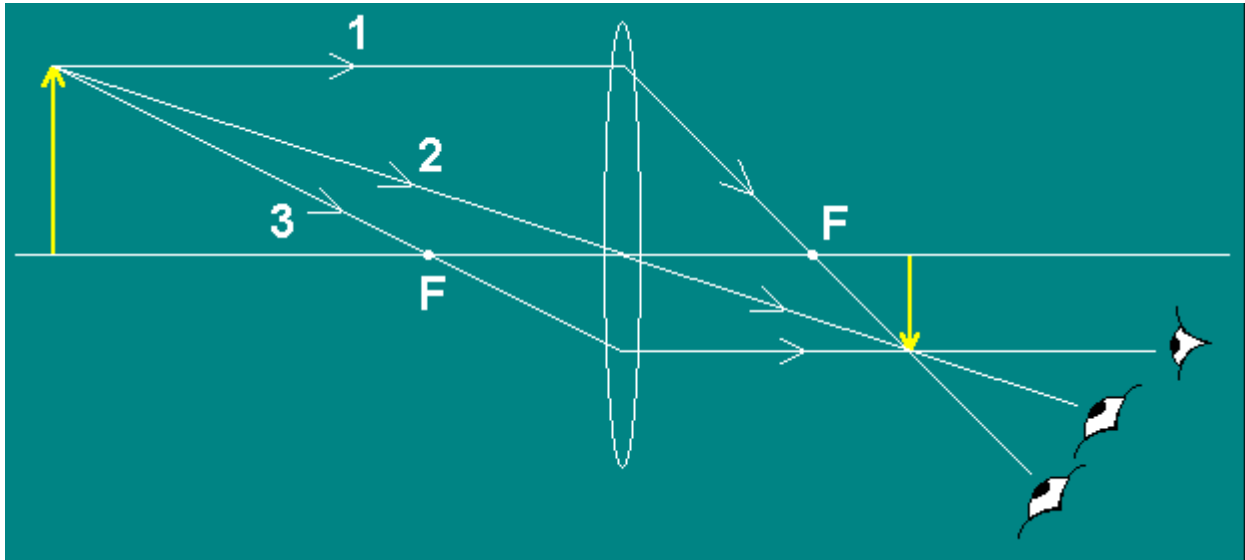

For our next case, we consider a configuration of subject and lens where the image is virtual, larger, and upright. This case corresponds to using a converging lens as a magnifying glass.

### Converging Lens Producing Larger Virtual Image

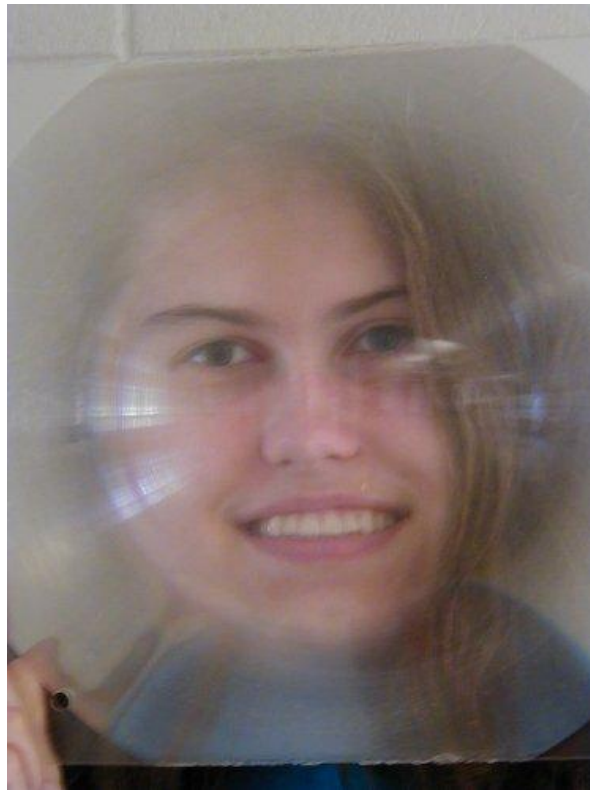

*Photo by Wendy Newman, June 5, 2001*

The secret here is that the subject must be close to the converging lens. More precisely, the subject needs to be between the left focal point  $F$  and the lens in order to produce a larger virtual image.

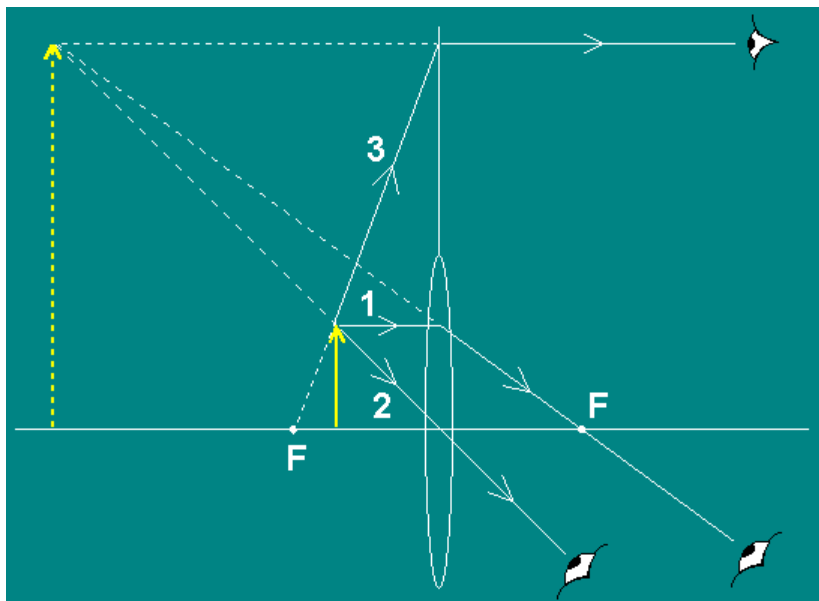

Notice that the arrow is between the left  $F$  and the lens. We can still sketch Ray 3 by placing our ruler to align the left  $F$  and the tip of the object arrow with the lens. We then find that we miss the lens.

No problem. Just extend the lens with a line. In a real situation, Ray 3 may indeed not reach the lens. But zillions of other rays do. We are restricted to using three key rays for quick sketches - so if necessary, we extend the lens.

Can you sketch the third main configuration for a converging lens, one that produces an inverted larger real image? Check out the inverted and larger wizard's head below.

### Converging Lens Producing Inverted Larger Real Image



*Photo by Doc Ruiz, February 27, 2002*

We are ready to summarize the characteristics of images produced by a converging lens for all the different object locations. The three ray-tracing examples you have analyzed, one which you did on your own, cover much of the ground for a concave mirror. We build on this to present a table which helps you visualize all cases.

Once again, imagine walking in from infinity from the far left until you touch the mirror. It is convenient for us to define regions for the converging lens. Point O is the center of the lens as before. Note the similarity to the regions we defined for the concave mirror, where the Point C was indicated at twice the focal distance on the left side of the concave mirror.

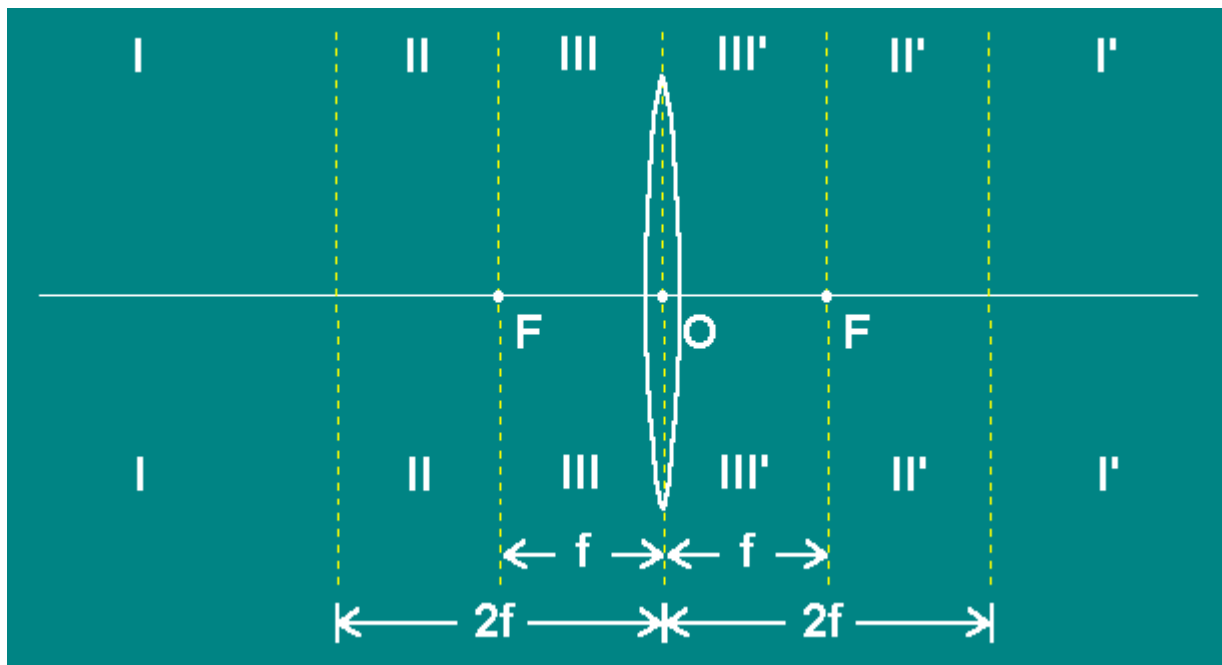

Object Location	Image Characteristics			
	Size	Location	Type	Orientation
Infinity	Zero	At Right F	Real	(Inverted)
Region I	Smaller	Region II'	Real	Inverted
At 2f	Equal	2f on Right	Real	Inverted
Region II	Larger	Region I'	Real	Inverted
Point F	Undefined			
Region III	Larger	Left of Object	Virtual	Upright
Point O	Equal	Point O	Virtual	Upright

Check out this cool interactive app by Tom Walsh: [Concave and Convex Lenses](#). Remember that a concave lens is the diverging lens and the convex lens is the converging lens. Can you verify the above table playing with the app?

## E4. Converging Lens Formula

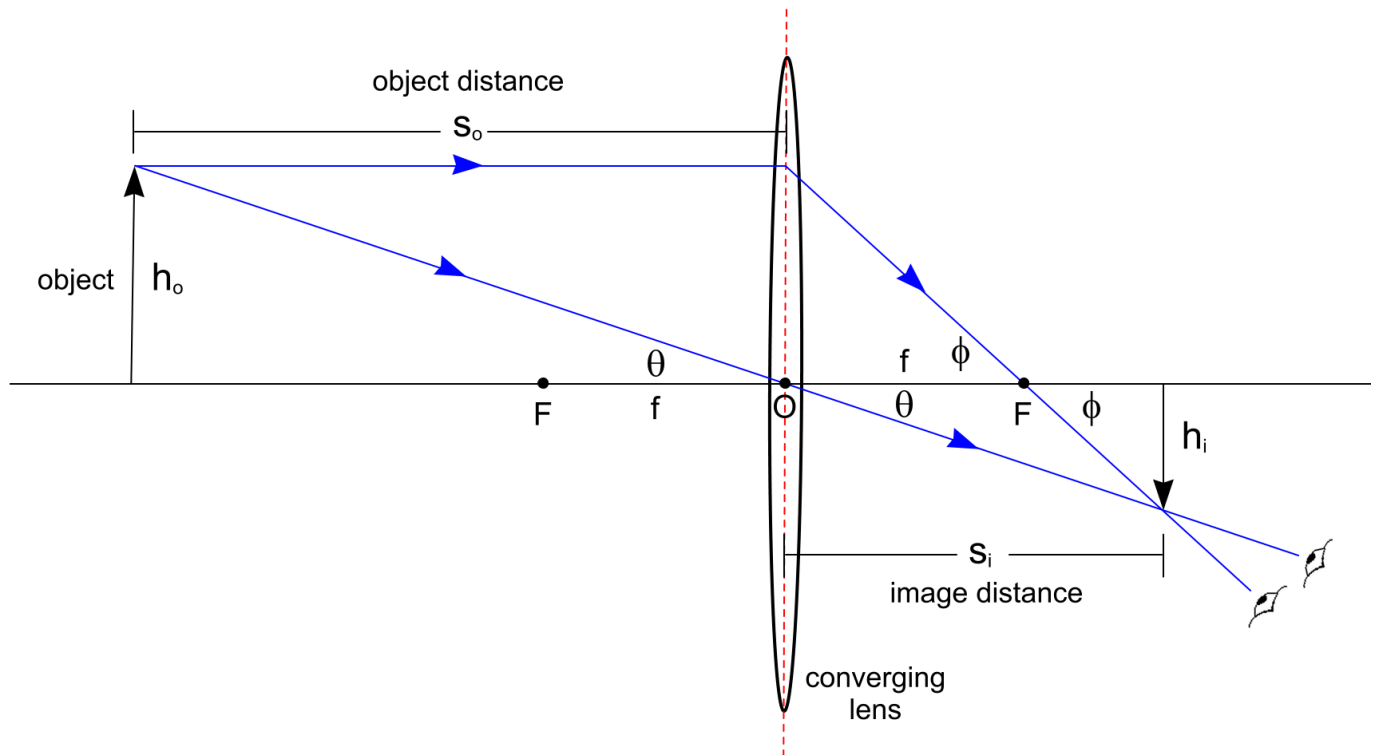

From the geometry we have

$$\tan \phi = \frac{h_o}{f} = \frac{h_i}{s_i - f} \quad \text{and} \quad \tan \theta = \frac{h_o}{s_o} = \frac{h_i}{s_i}.$$

We now proceed to derive two basic formulas similar to what we did for the concave mirror. It would be nice to be able to figure out the image distance  $s_i$  and the magnification like we did earlier. First we derive the image distance formula. From

$$\frac{h_o}{f} = \frac{h_i}{s_i - f} \quad \text{and} \quad \frac{h_o}{s_o} = \frac{h_i}{s_i},$$

we can proceed with

$$\frac{s_i - f}{f} = \frac{h_i}{h_o} \quad \text{and} \quad \frac{s_i}{s_o} = \frac{h_i}{h_o}.$$

The left equation looks simpler than what we found for the concave mirror. We continue below.

$$\frac{s_i - f}{f} = \frac{s_i}{s_o}$$

$$s_o(s_i - f) = s_i f$$

$$s_o s_i - s_o f = s_i f$$

$$s_o s_i = s_o f + s_i f$$

$$\frac{s_i s_o}{f} = s_o + s_i$$

$$\frac{s_o + s_i}{s_i s_o} = \frac{1}{f}$$

$$\frac{1}{s_i} + \frac{1}{s_o} = \frac{1}{f}$$

$$\frac{1}{s_o} + \frac{1}{s_i} = \frac{1}{f}$$

We can get the magnification by comparing the height of the image to the height of the object.

The magnification of the image relative to the object is found from  $\frac{s_i}{s_o} = \frac{h_i}{h_o}$ . We can write

$$M = -\frac{s_i}{s_o},$$

where the minus sign is included since the image is upside down. Now notice that when the object distance  $s_o \rightarrow \infty$ , the image distance  $s_i \rightarrow f$ . Also note that the size of the image

goes to zero since  $M = -\frac{s_i}{s_o} \rightarrow \frac{s_i}{\text{large}} \rightarrow 0$  as  $s_o \rightarrow \infty$ . Note that positive  $s_i$  means to

the right of the lens. This convention makes sense since for lenses, positive image space can be defined as the space on the right side since light goes through the glass rather than reflecting



as with the mirrors. So positive image space for a mirror is on the same side as from where the light comes since reflection is natural for a mirror. Positive image space for a lens is natural on the right side of the lens since light enters the glass, refracts, and passes through it. Negative image space for a lens is on the left side since light is coming in from the left in our diagrams.

### E5. Diverging Lens Formula

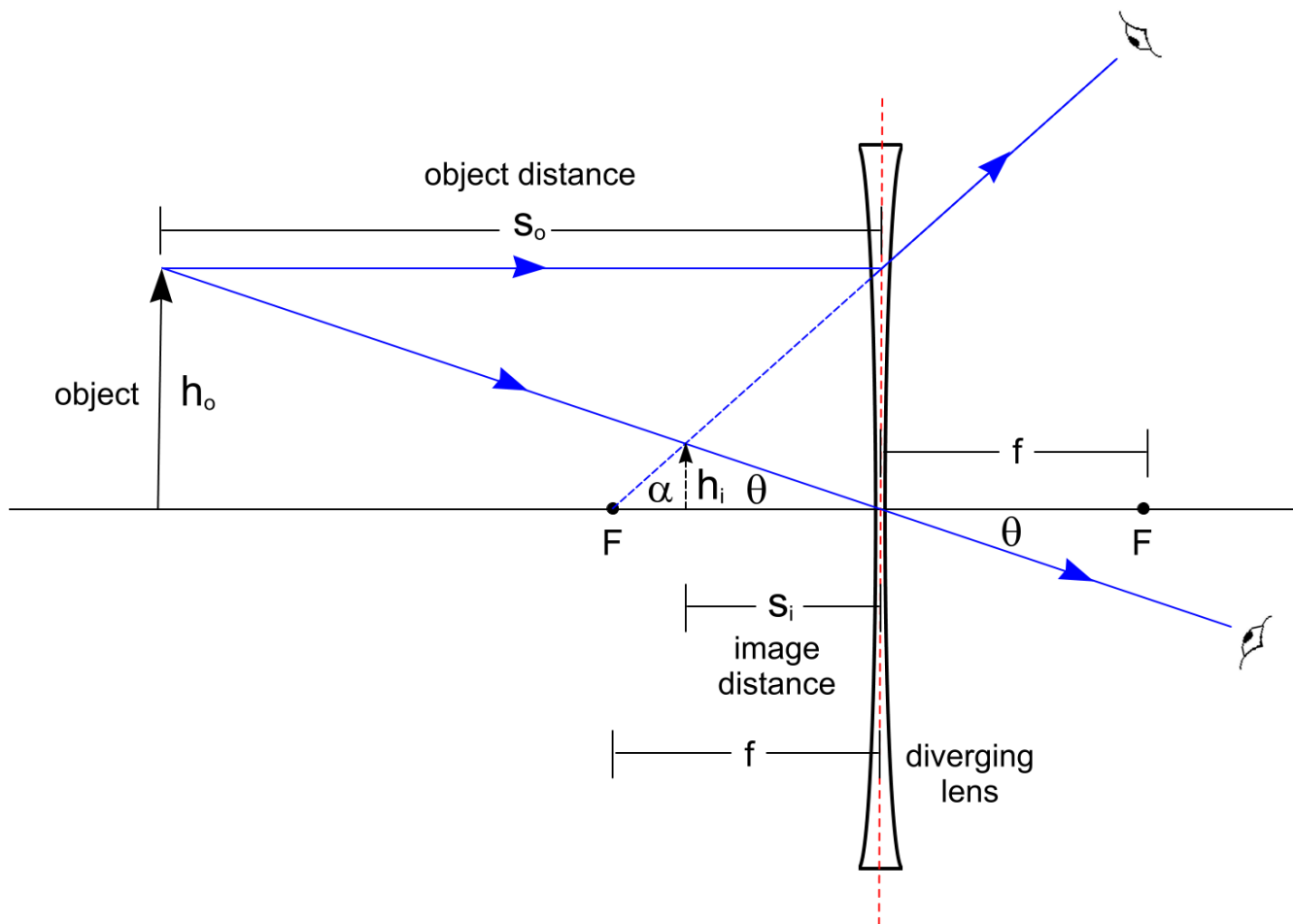

From the geometry we have

$$\tan \alpha = \frac{h_i}{f - s_i} = \frac{h_o}{f} \quad \text{and} \quad \tan \theta = \frac{h_o}{s_o} = \frac{h_i}{s_i}.$$

We now proceed to derive two basic formulas similar to what we did for the converging lens. From

$$\frac{h_i}{f - s_i} = \frac{h_o}{f} \quad \text{and} \quad \frac{h_o}{s_o} = \frac{h_i}{s_i},$$

we can proceed with

$$\frac{f - s_i}{f} = \frac{h_i}{h_o} \quad \text{and} \quad \frac{s_i}{s_o} = \frac{h_i}{h_o}.$$

These equations are similar to those we found for the converging lens. We continue below.

$$\frac{f - s_i}{f} = \frac{s_i}{s_o}$$

$$s_o(f - s_i) = s_i f$$

$$s_o f - s_o s_i = s_i f$$

$$s_o f - s_i f = s_o s_i$$

$$s_o - s_i = \frac{s_i s_o}{f}$$

$$\frac{s_o - s_i}{s_i s_o} = \frac{1}{f}$$

$$\frac{1}{s_i} - \frac{1}{s_o} = \frac{1}{f}$$

$$\frac{1}{s_o} - \frac{1}{s_i} = -\frac{1}{f}$$

But according to our convention  $s_i < 0$  since it is in negative lens image space. So we can change the sign in the above equation due to this sign convention. If we define the focal length for a diverging lens such that  $f < 0$ , then we get the same equation for both the converging and diverging lenses.

$$\frac{1}{s_o} + \frac{1}{s_i} = \frac{1}{f}$$

The same magnification formula works

$$M = -\frac{s_i}{s_o}$$

Note that for  $s_i < 0$  we have  $M > 0$ , meaning the orientation is upright.

Now notice that when the object distance  $s_o \rightarrow \infty$ , the image distance  $s_i \rightarrow f$  on the left side of the lens since  $f < 0$  for a diverging lens. Also note that the size of the image goes to

zero since  $M = -\frac{s_i}{s_o} \rightarrow \frac{s_i}{\text{large}} \rightarrow 0$  as  $s_o \rightarrow \infty$ .

### E6. A Two-Lens System

Before considering two lenses, let's gain confidence in using the lens formula by analyzing a case where we know the answer. Below is a super symmetric situation drawing carefully using

our ray rules. We can see that  $s_i = s_o = 2f$  and  $M = -\frac{s_i}{s_o} = -1$ .

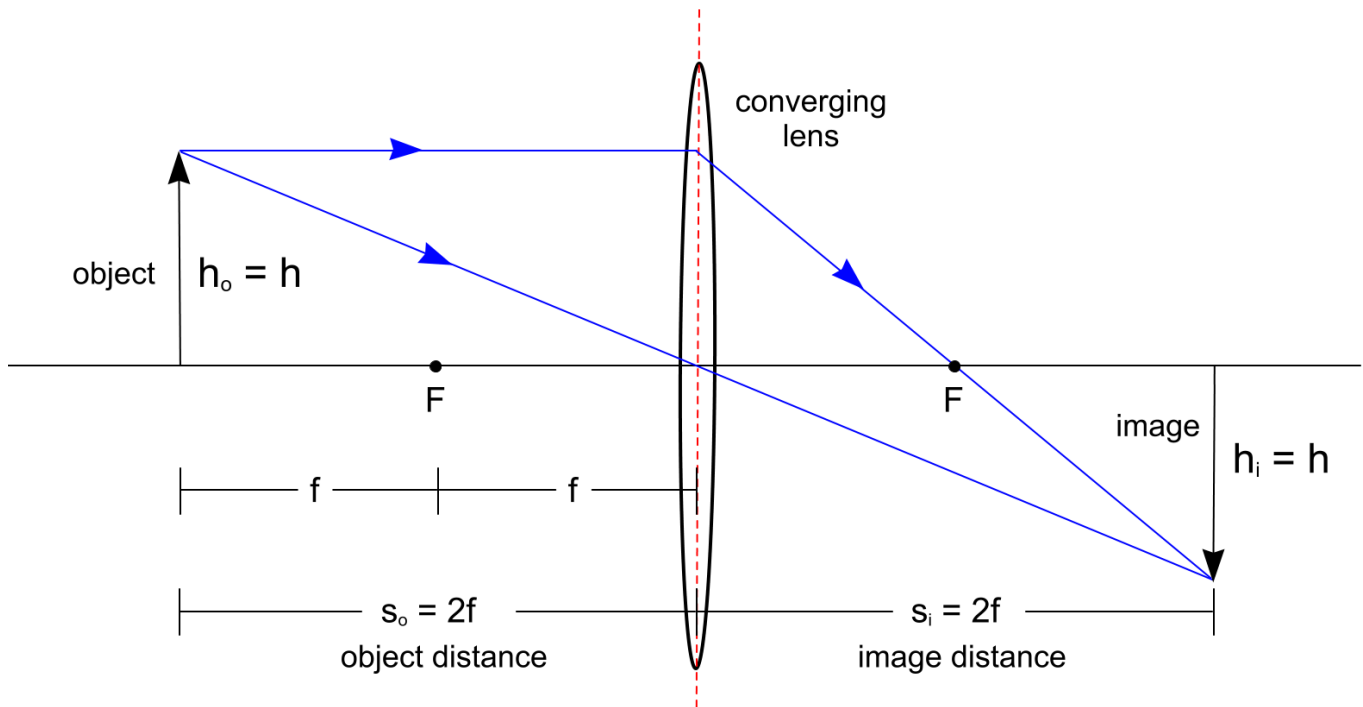

Let's use the formula with  $s_o = 2f$ . Then

$$\frac{1}{s_o} + \frac{1}{s_i} = \frac{1}{f} \quad \text{gives} \quad \frac{1}{2f} + \frac{1}{s_i} = \frac{1}{f}, \quad \text{and}$$

$$\frac{1}{s_i} = \frac{1}{2f},$$

$$s_i = 2f.$$

Remember the concave mirror when you are at twice the focal length, which is a radius distance away, you have the image inverted right under the object. The image is the same size. We have the converging lens version of the same-size real inverted image as

$$M = -\frac{s_i}{s_o} = -\frac{2f}{2f} = -1.$$

Now we are ready for a two-lens system. See below where we have added a second lens, with focal length half of the first lens, where its center coincides with a focal point  $F$  of the first lens. Therefore, the separation between the two lenses is  $d = f$ . The final image in the previous example now becomes an intermediate image.

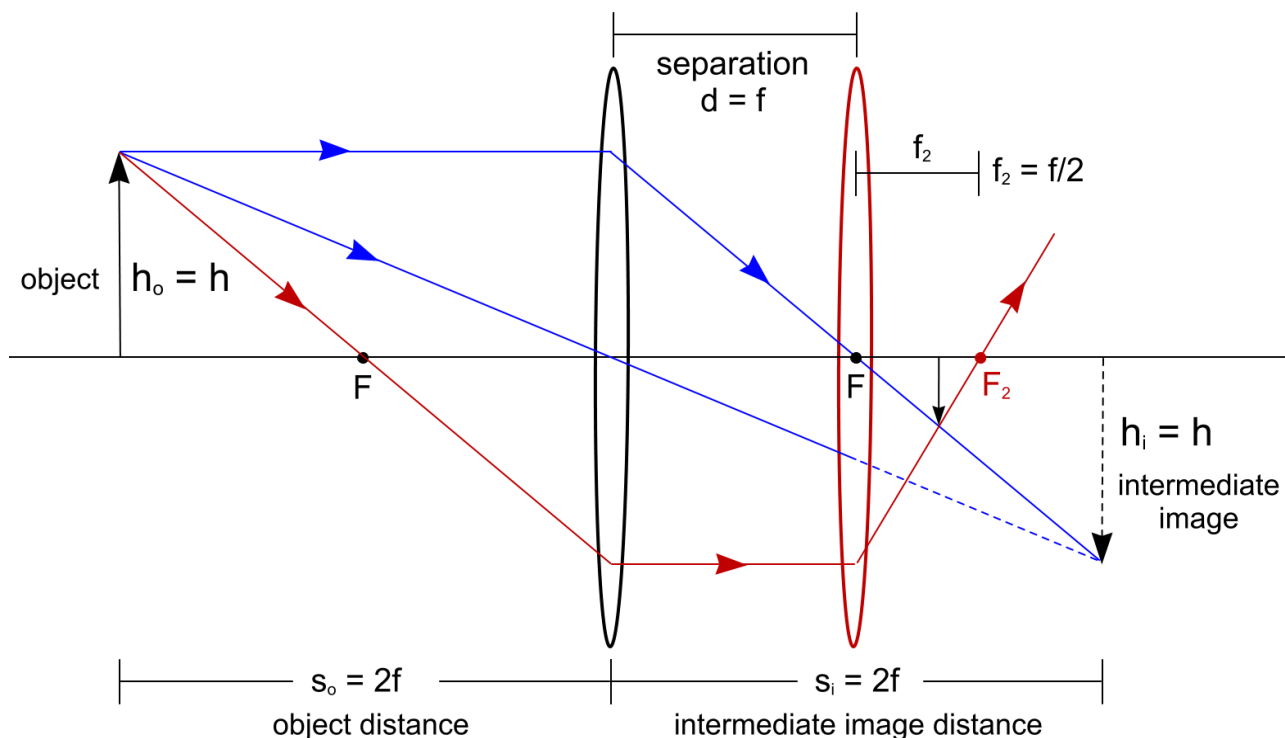

We can locate the final image by using Ray 3 for the first lens. The outgoing parallel ray is Ray 1 for the second lens; therefore, it refracts heading toward  $F_2$ . To see specific numbers, let  $f = 100$  cm. The final image looks like  $2/3$  of  $f/2$ , which would be  $(2/3)(50) = 33$  cm. How do we get this final image distance from the formula?

Well, let's use the intermediate image to serve as the object for the second lens. But it is to the right of the second lens, 100 cm beyond the second lens. So try -100 cm as the object distance. The math suggests this choice since when the image was on the unexpected side, the image distance was negative. Mathematics is teaching us the physics. Proceeding for the second lens, the general formula

$$\frac{1}{s_o} + \frac{1}{s_i} = \frac{1}{f} \quad \text{becomes} \quad \frac{1}{-100} + \frac{1}{s_i} = \frac{1}{50}.$$

Solving for  $s_i$ ,

$$\frac{1}{s_i} = \frac{1}{50} + \frac{1}{100},$$

$$\frac{1}{s_i} = \frac{2}{100} + \frac{1}{100}$$

$$\frac{1}{s_i} = \frac{3}{100}$$

$$s_i = \frac{100}{3} = 33 \text{ cm}.$$

The magnification formula for the second lens gives

$$M = -\frac{s_i}{s_o} = -\frac{33}{(-100)} = \frac{1}{3} > 0,$$

which means it does not flip compared to the intermediate image. Both have the same orientation and indeed it looks from the ray diagram that the magnification is about  $1/3$ . But the total magnification shows an inversion relative to the original object.

$$M = M_1 M_2 = (-1)\left(+\frac{1}{3}\right) = -\frac{1}{3}$$

## E7. The Lensmaker's Formula

The lensmaker's formula related the index of refraction of the lens and the radii of curvature of its surfaces to the resulting focal length of the lens. Our derivation of this cool formula will follow that of C. Bond, whose derivation I found on the Internet.

We start the analysis by analyzing one interface: the air-glass boundary and related parameters.

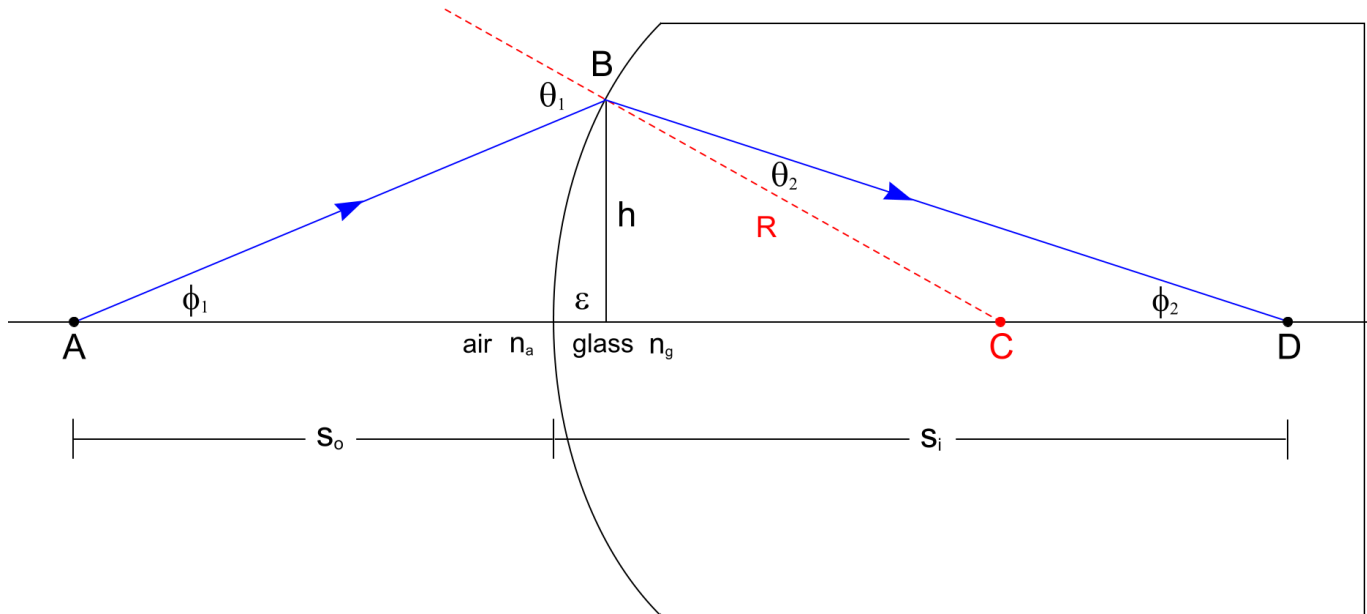

We start by using the law of sines for the triangle ABC placing our attention on  $\angle BAC = \phi_1$  and  $\angle ABC = 180^\circ - \theta_1$ . The law of sines states that the sine of the angle over its respective opposite side in the triangle is the same for all three angles.

$$\frac{\sin \phi_1}{R} = \frac{\sin(180^\circ - \theta_1)}{s_o + R}$$

Now use the law of sines for the triangle CBD focusing on the angles  $\theta_2$  and  $\phi_2$ .

$$\frac{\sin \theta_2}{s_i - R} = \frac{\sin \phi_2}{R}$$

Note that  $\sin(180^\circ - \theta_1) = \sin \theta_1$  since the sines of supplementary angles are equal. Therefore

$$\frac{\sin \phi_1}{R} = \frac{\sin \theta_1}{s_o + R}$$

If we add Snell's law  $n_a \sin \theta_1 = n_g \sin \theta_2$ , we get three equations.

$$\frac{\sin \theta_1}{\sin \theta_2} = \frac{n_g}{n_a} \qquad \frac{\sin \theta_1}{s_o + R} = \frac{\sin \phi_1}{R} \qquad \frac{\sin \theta_2}{s_i - R} = \frac{\sin \phi_2}{R}$$

Dividing the middle equation by the third one, we get

$$\frac{\sin \theta_1}{\sin \theta_2} \left[ \frac{s_i - R}{s_o + R} \right] = \frac{\sin \phi_1}{\sin \phi_2} .$$

Now we use Snell's law, the first equation, to arrive at

$$\frac{n_g}{n_a} \left[ \frac{s_i - R}{s_o + R} \right] = \frac{\sin \phi_1}{\sin \phi_2} .$$

Finally it's time for approximations. We assume that rays are close to the optic axis and incoming rays have very small angles of approach. Such rays are called paraxial rays and the approximation is called the paraxial approximation. The  $\epsilon$  in our figure is small and we can write

$$\tan \phi_1 = \frac{h}{s_o} , \quad \tan \phi_2 = \frac{h}{s_i} , \quad \text{and} \quad \frac{\tan \phi_1}{\tan \phi_2} = \frac{s_i}{s_o} .$$

Furthermore, small angles imply

$$\sin \theta \approx \tan \theta \approx \theta .$$

Let's pause to check this out. Let's pick a decent size angle compared to the very small, e.g.,

$$10^\circ = 10^\circ \frac{\pi}{180^\circ} \text{ radians} = 0.17 \text{ rad} .$$

$$\sin 0.17 = 0.17 \quad \text{and} \quad \tan 0.17 = 0.17 .$$

Let's push it to the even larger  $20^\circ = 0.34 \text{ rad}$  . Then,

$$\sin 0.34 = 0.33 \quad \text{and} \quad \tan 0.34 = 0.35 .$$

A pretty good approximate if it even works for  $20^\circ$  to about  $(0.01/0.33) \times 100\% = 3\%$ .

Here is a summary of our equations:

$$\frac{n_g}{n_a} \left[ \frac{s_i - R}{s_o + R} \right] = \frac{\sin \phi_1}{\sin \phi_2} \quad \text{and} \quad \frac{\tan \phi_1}{\tan \phi_2} = \frac{s_i}{s_o}$$

Now applying  $\sin \theta \approx \tan \theta \approx \theta$ , we have

$$\frac{n_g}{n_a} \left[ \frac{s_i - R}{s_o + R} \right] = \frac{\phi_1}{\phi_2} \quad \text{and} \quad \frac{\phi_1}{\phi_2} = \frac{s_i}{s_o}.$$

Combining these,

$$\frac{n_g}{n_a} \left[ \frac{s_i - R}{s_o + R} \right] = \frac{s_i}{s_o}.$$

There is a nice rearranged form of this equation. Let's get it.

$$n_g (s_i - R)s_o = n_a s_i (s_o + R)$$

$$n_g s_i s_o - n_g R s_o = n_a s_i s_o + n_a s_i R$$

$$n_g s_o s_i - n_g s_o R = n_a s_o s_i + n_a s_i R$$

$$\frac{(n_g - n_a)}{R} s_o s_i = n_a s_i + n_g s_o$$

$$\frac{(n_g - n_a)}{R} = \frac{n_a s_i + n_g s_o}{s_o s_i}$$

$$\frac{(n_g - n_a)}{R} = \frac{n_a}{s_o} + \frac{n_g}{s_i}$$

$$\frac{n_a}{s_o} + \frac{n_g}{s_i} = \frac{(n_g - n_a)}{R}$$



To emphasize this equation stands for the left interface of the lens, we add subscripts 1.

$$\frac{n_a}{s_{o1}} + \frac{n_g}{s_{i1}} = \frac{(n_g - n_a)}{R_1}$$

Since the glass side does not go on forever, let  $d$  be the thickness, i.e., distance from the left interface to the right. For the right boundary, we go from glass to air. Therefore,

$$\frac{n_g}{s_{o2}} + \frac{n_a}{s_{i2}} = \frac{(n_a - n_g)}{R_2}$$

The object distance for the second interface can be seen in the figure as  $s_{o2} = d - s_{i1}$ .

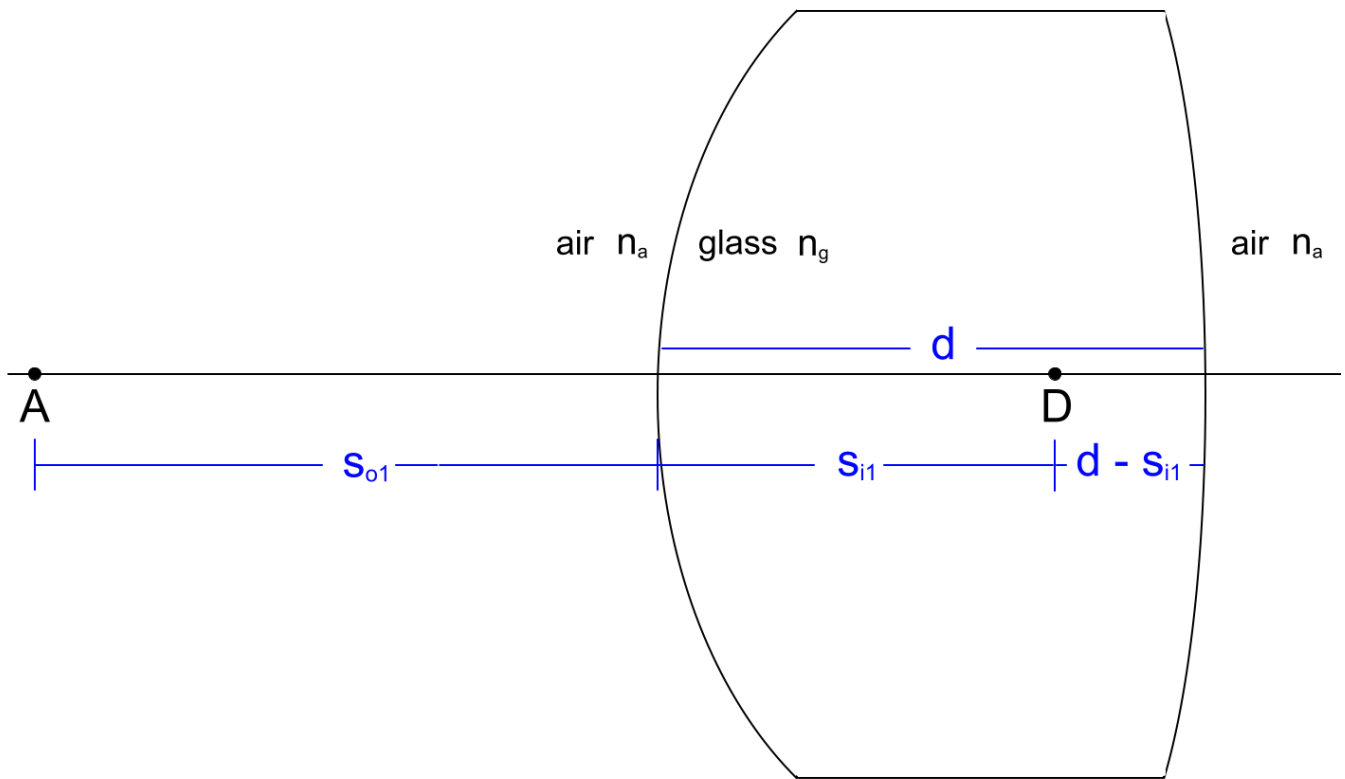

The pair of equations for the two boundaries are then

$$\frac{n_a}{s_{o1}} + \frac{n_g}{s_{i1}} = \frac{(n_g - n_a)}{R_1} \quad \text{and} \quad \frac{n_g}{d - s_{i1}} + \frac{n_a}{s_{i2}} = \frac{(n_a - n_g)}{R_2}$$

Adding these equations,

$$\frac{n_a}{s_{o1}} + \frac{n_g}{s_{i1}} + \frac{n_g}{d - s_{i1}} + \frac{n_a}{s_{i2}} = \frac{(n_g - n_a)}{R_1} + \frac{(n_a - n_g)}{R_2}$$

$$\frac{n_a}{s_{o1}} + \frac{n_g}{s_{i1}} + \frac{n_g}{d - s_{i1}} + \frac{n_a}{s_{i2}} = (n_g - n_a) \left[ \frac{1}{R_1} - \frac{1}{R_2} \right]$$

$$\frac{n_a}{s_{o1}} + n_g \left[ \frac{1}{s_{i1}} + \frac{1}{d - s_{i1}} \right] + \frac{n_a}{s_{i2}} = (n_g - n_a) \left[ \frac{1}{R_1} - \frac{1}{R_2} \right]$$

$$\frac{n_a}{s_{o1}} + n_g \left[ \frac{(d - s_{i1}) + s_{i1}}{s_{i1}(d - s_{i1})} \right] + \frac{n_a}{s_{i2}} = (n_g - n_a) \left[ \frac{1}{R_1} - \frac{1}{R_2} \right]$$

$$\frac{n_a}{s_{o1}} + n_g \left[ \frac{d}{s_{i1}(d - s_{i1})} \right] + \frac{n_a}{s_{i2}} = (n_g - n_a) \left[ \frac{1}{R_1} - \frac{1}{R_2} \right]$$

$$\frac{n_a}{s_{o1}} + \frac{n_a}{s_{i2}} = (n_g - n_a) \left[ \frac{1}{R_1} - \frac{1}{R_2} \right] - n_g \left[ \frac{d}{s_{i1}(d - s_{i1})} \right]$$

For a thin lens  $d \approx 0$  and

$$\frac{n_a}{s_{o1}} + \frac{n_a}{s_{i2}} = (n_g - n_a) \left[ \frac{1}{R_1} - \frac{1}{R_2} \right].$$

Using  $n_a = 1$  and  $n_g = n$ ,

$$\frac{1}{s_{o1}} + \frac{1}{s_{i2}} = (n - 1) \left[ \frac{1}{R_1} - \frac{1}{R_2} \right].$$

We can assign  $s_{o1} = s_o$ , the distance from the object to the then lens. Since  $s_{i2}$  is the distance to the final image, we can assign  $s_{i2} = s_i$ . Then, the equation becomes

$$\frac{1}{s_o} + \frac{1}{s_i} = (n-1) \left[ \frac{1}{R_1} - \frac{1}{R_2} \right].$$

But for a thin lens

$$\frac{1}{s_o} + \frac{1}{s_i} = \frac{1}{f}.$$

Therefore,

$$\frac{1}{f} = (n-1) \left[ \frac{1}{R_1} - \frac{1}{R_2} \right].$$

This cool formula is called the lensmaker's formula. The lensmaker's formula relates the effective overall focal length of the lens to the index of refraction of the glass and curvatures of the two lens surfaces.

### **Lensmaker Below (Is the lens converging or diverging?)**

